

# ASSEMBLY AND INSTALLATION INSTRUCTIONS

W0394

**WARNING:** TO AVOID RISK OF ELECTRICAL SHOCK, BE SURE TO SHUT OFF POWER WHILE INSTALLING OR SERVICING THIS FIXTURE.

**NOTE:** 1. Before installing, consult local electrical codes for wiring and grounding requirements.  
2. READ AND SAVE THESE INSTRUCTIONS.

## Hardware Package (included):

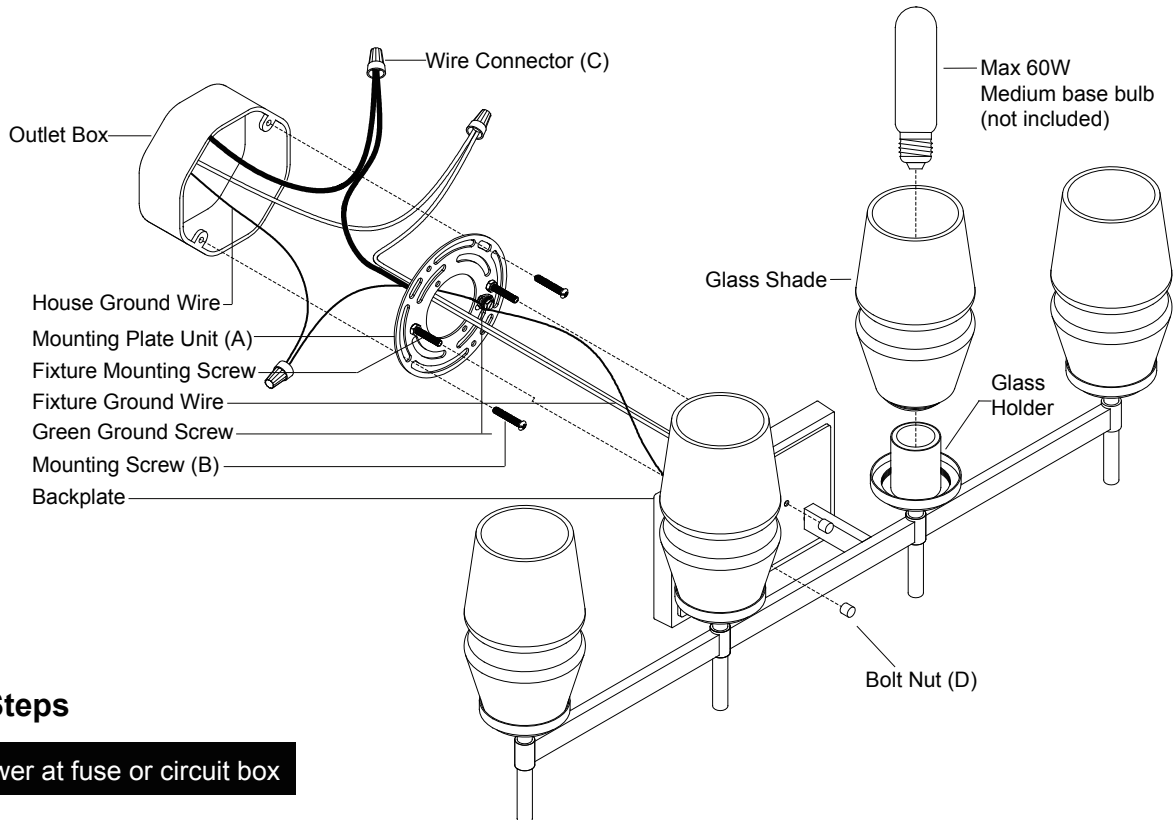
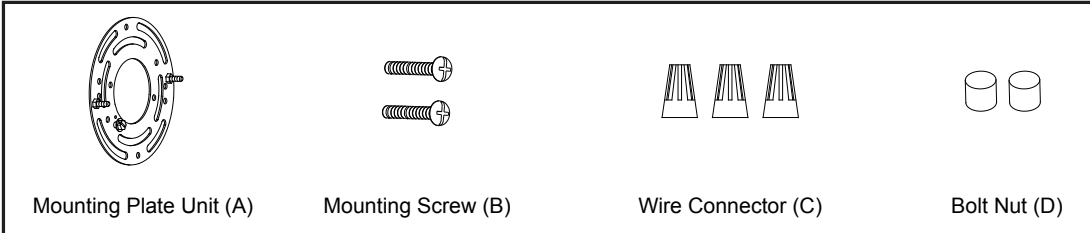

## Installation Steps

Turn off the power at fuse or circuit box





1. Attach mounting plate unit (A) to the outlet box using two mounting screws (B). Adjust the length of the preinstalled fixture mounting screws if necessary.  
**Note:** Make sure that the fixture mounting screws are lined up horizontally to make the fixture level.
2. Pull out the wires and ground wire from the outlet box. Make wire connections using the wire connectors (C) as follows:
  - Connect the hot wire (black insulation) from the fixture to the black wire from the power source.
  - Connect the neutral wire (white insulation) from the fixture to the white wire from the power source.
  - Attach the fixture ground wire (bare wire) to the mounting plate unit (A) with the green ground screw, then connect it to the house ground wire with the wire connectors (C).Carefully put the wires back into the outlet box.

3. Attach the backplate to the mounting plate unit (A) by aligning and inserting the two fixture mounting screws from the mounting plate unit (A) into the open holes on the backplate, then screw it with the two bolt nuts (D).
4. Rotate the glass shade onto the glass holder. Install 4 X 60W medium base bulbs (not included). See relamping label at socket area or packaging for maximum wattage allowed.

**Turn on the power at fuse or circuit box.**

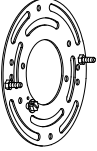
The following parts are available for re-order if damaged or missing.

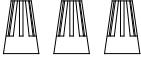
**Spare Parts List:**

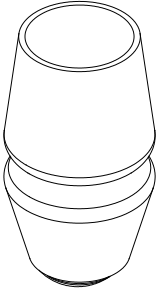
				
Mounting Plate Unit (A)	Mounting Screw (B)	Wire Connector (C)	Bolt Nut (D)	

↑ Assembly Kit 6335MM (1 SET)

